

4.8W, Wide input, isolated & regulated
dual output, IGBT dedicated DC-DC converter

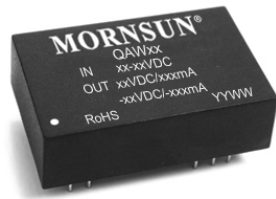

Patent Protection RoHS

FEATURES

- 2:1 wide input voltage range
- Efficiency up to 85%
- Up to 3KVDC isolation
- Short circuit protection
- Output over-voltage protection
- Operating temperature range:-40°C to +85°C
- Industry standard pin-out
- IGBT dedicated regulated DC-DC converter

QAW series are designed for the IGBT driver, offer 4.8W of output, with output over-voltage protection and short-circuit protection. General application includes:

- Universal converter
- AC servo drive system
- Electric welding machine
- Uninterruptible power supply (UPS)

Selection Guide

Part No.	Input		Output		Efficiency (%Min./Typ) @ Full Load	Max. Capacitive Load (µF)
	Input Voltage (VDC)	Input Current (mA,Typ) Full Load/No Load	Output Voltage (VDC)+Vo/-Vo	Output Current (mA)+Io/-Io		
QAW01	12(9-18)	471/16	+15/-9	±200/±10	85	1000
QAW02	24(18-36)	235/8	+15/-9	±200/±10	85	

Input Specifications

Item	Operating Conditions	Min.	Typ.	Max.	Unit
Input Voltage	12VDC input	-0.7	--	25	VDC
	24VDC input	-0.7	--	50	
Starting Voltage	12VDC input	--	--	9	
	24VDC input	--	--	18	
Input Filter	Capacitor filter				

Output Specifications

Item	Operating Conditions	Min.	Typ.	Max.	Unit
Output Power	Main output(+15V output)	0.24	--	4.8	W
Output Voltage Accuracy	Supplement output(-9V output)	--	±1	±2	%
	Full load, Input voltage from low to high	--	±3	±5	
Line Regulation	Input voltage varies by ±1%	--	±0.2	±0.5	
Load Regulation	5% to 100% load	--	±0.5	±1	
Transient Recovery Time	25% load step change	--	0.5	2	µs
Transient Response Deviation		--	±2.5	±5	%
Temperature Drift Coefficient	100% load	--	--	±0.03	%/°C
Ripple & Noise*	20MHz bandwidth	--	100	200	mVp-p
Output Over-voltage Protection		110	120	140	% Vo
Output Short Circuit Protection	Input voltage range	Continuous, self-recovery			

Note: * Ripple and noise tested with "parallel cable" method, please see DC-DC Converter Application Notes for specific operation methods.

General Specifications

Item	Operating Conditions	Min.	Typ.	Max.	Unit
------	----------------------	------	------	------	------

Isolation Voltage	Input-output, with the test time of 1 minute and the leak current lower than 1mA	3000	--	--	VDC
Isolation Resistance	Input-output, Isolation voltage 500VDC	1000	--	--	MΩ
Isolation Capacitance	Input-output, 100KHz/0.1V	--	100	--	pF
Operating Temperature	Power derating $\geq 71^{\circ}\text{C}$, (see Fig. 1)	-40	--	85	$^{\circ}\text{C}$
Storage Temperature		-55	--	125	
Lead Temperature	Welding spot is 1.5mm away from the casing, 10 seconds	--	--	300	
Casing Temperature Rise	Ta=25 $^{\circ}\text{C}$	--	30	40	
Storage humidity	Non-condensing	5	--	95	%RH
Switching frequency	100% load, nominal input voltage	--	300	--	KHz
MTBF	MIL-HDFK-217F@25 $^{\circ}\text{C}$	1000	--	--	K hours

Physical Specifications

Casing Material	Black flame-retardant and heat-resistant plastic (UL94-V0)
Package Dimensions	31.60*20.30*10.20 mm
Weight	14g (Typ.)
Cooling Method	Free air convection

EMC Specifications

EMI	Conducted Disturbance	CISPR22/EN55022	CLASS A (see Fig. 4-② for recommended circuit)
	Radiated Emission	CISPR22/EN55022	CLASS A (see Fig. 4-② for recommended circuit)
EMS	Electrostatic Discharge	IEC/EN61000-4-2	Contact $\pm 4\text{KV}$ perf. Criteria B
	Radiation Immunity	IEC/EN61000-4-3	10V/m perf. Criteria A
	EFT	IEC/EN61000-4-4	$\pm 2\text{KV}$ (see Fig. 4-① for recommended circuit) perf. Criteria B
	Surge Immunity	IEC/EN61000-4-5	$\pm 2\text{KV}$ (see Fig. 4-① for recommended circuit) perf. Criteria B
	Conducted disturbance Immunity	IEC/EN61000-4-6	3 Vr.m.s perf. Criteria A
	Immunities of voltage dip, voltage drop and short interruption	IEC/EN61000-4-29	0%-70% perf. Criteria B

Product Characteristic Curve

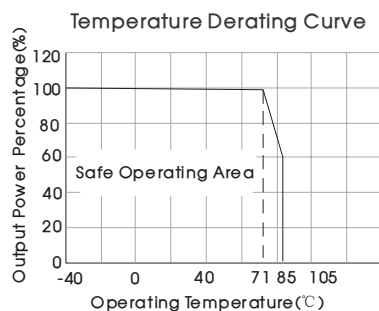
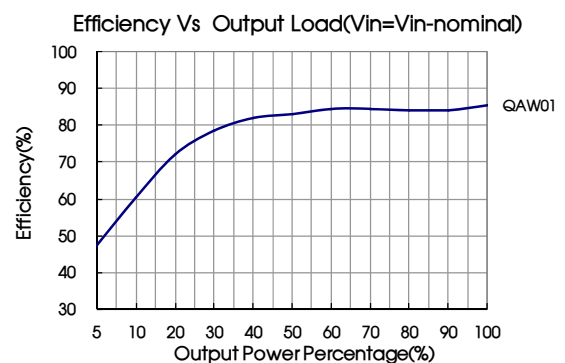
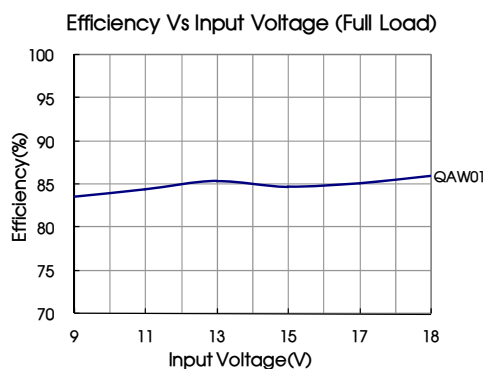
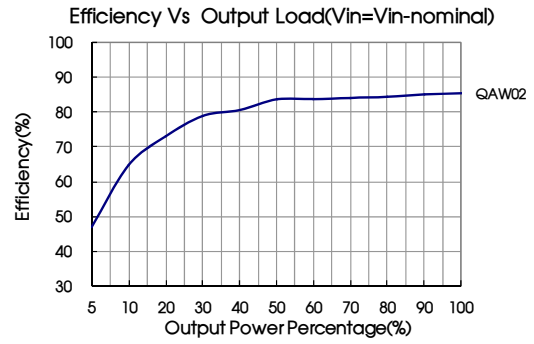
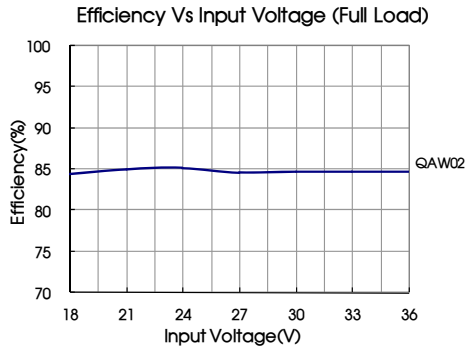

Fig. 1





Design Reference

1. Typical application

All the IGBT driver of this series are tested according to the recommended circuit (see Fig. 2) before delivery.

If it is required to further reduce input and output ripple, properly increase the input & output of additional capacitors C_{in} and C_{out} or select capacitors of low equivalent impedance provided that the capacitance is no larger than the max. capacitive load of the product.

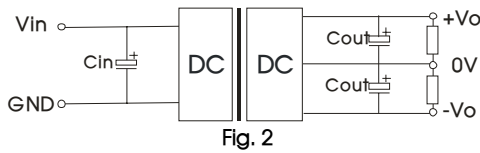

Fig. 2

V_{in}	12V/24V
C_{in}	100 μ F
C_{out}	100 μ F

1. Typical application

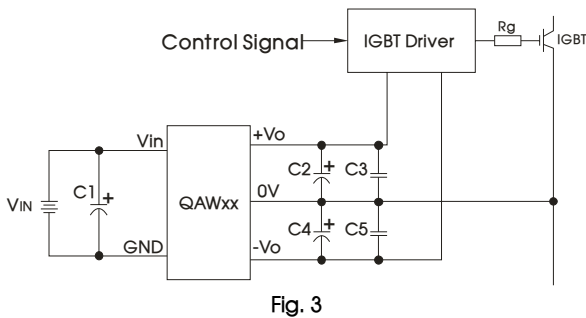

Fig. 3

C1	100 μ F/63V (Electrolytic capacitor)
C2 / C4	100 μ F/35V (Electrolytic capacitor)
C3 / C5	10 μ F/25V (Ceramic capacitor)

Application Notes

1. The wire between the converter and IGBT driver must as short as possible.
2. External filter capacitors should be connected as close as possible to the IGBT driver.
3. To ensure the high peak gate current, the filter capacitors should be electrolytic capacitor and ceramic capacitor collocation.
4. The output average power of the IGBT driver should be less than the output power of DC-DC module.

2. EMC solution-recommended circuit(QAW01)

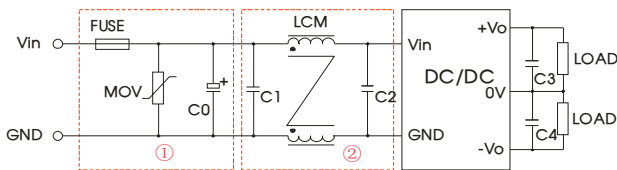

EMC solution-recommended circuit(QAW02)

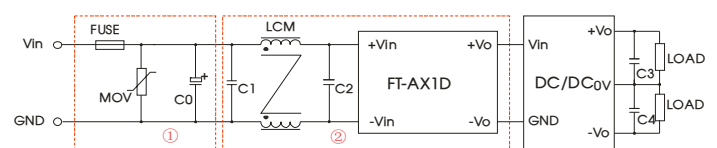
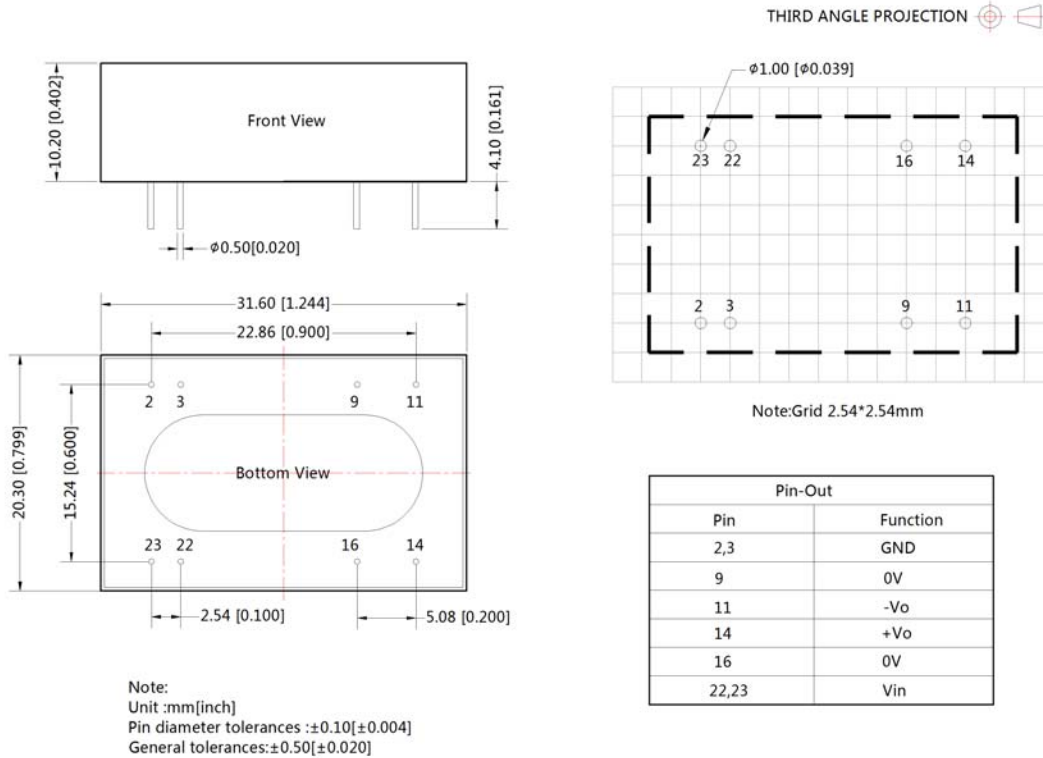

Fig. 4

Parameters	QAW01	QAW02
FUSE	Choose according to practical input current	
MOV	S14K25	S14K35
C0	680 μ F/25V	330 μ F/50V
C1, C2	4.7 μ F/50V	
C3, C4	Refer to the C_{out} in Fig.2	
LCM	1mH	3.3mH
Module	--	FT-AX1D

- The product does not support output in parallel with power per liter or hot-swappable use
- For more information please find the application notes on www.mornsun-power.com

Dimensions and Recommended Layout



Notes:

- Packing Information please refer to 'Product Packing Information'. Packing bag number: 58200013;
- The lead connecting the power supply module and IGBT driver should be as short as possible during use;
- The output filtering capacitor should be as close as possible to the power supply module and IGBT driver;
- The peak of the IGBT driver gate drive current is high, so low internal resistance electrolytic capacitor is recommended to be used for the power supply module output filter capacitor;
- The average output power of the driver must be lower than that of the power supply module;
- Consider fixing with glue near the module if being used in vibration occasion;
- The max. capacitive load should be tested within the input voltage range and under full load conditions;
- Unless otherwise specified, data in this datasheet should be tested under the conditions of $T_a=25^{\circ}\text{C}$, humidity<75% when inputting nominal voltage and outputting rated load;
- All index testing methods in this datasheet are based on our Company's corporate standards;
- The performance indexes of the product models listed in this manual are as above, but some indexes of non-standard model products will exceed the above-mentioned requirements, and please directly contact our technicians for specific information;
- We can provide product customization service;
- Specifications of this product are subject to changes without prior notice.

MORNSUN Guangzhou Science & Technology Co., Ltd.

Address: No. 5, Kehui St. 1, Kehui Development Center, Science Ave., Guangzhou Science City, Luogang District, Guangzhou, P. R. China
Tel: 86-20-38601850-8801 Fax: 86-20-38601272 E-mail: info@mornsun.cn