

3W, AC-DC converter

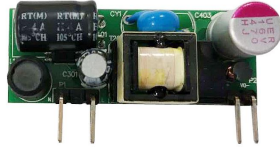
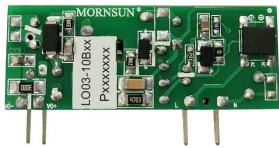

RoHS

FEATURES

- 85 - 264V Universal AC or wide 100 - 370V DC Input
- Operating ambient temperature range -25°C to +70°C
- High I/O isolation test voltage up to 3000VAC
- Regulated output, Low ripple & noise
- Output short circuit, overcurrent protection
- High efficiency, high reliability
- 2 years warranty

LO03-10Bxx series is one of Mornsun's compact size power converter. It features universal AC input and at the same time accepts DC input voltage, high efficiency, high reliability, reinforced isolation. It offers good EMC performance compliant to IEC/EN61000-4 and CISPR32/EN55032 and meets IEC/EN/UL62368 standards. The converters are widely used in industrial, office and civil applications. For extremely harsh EMC environment, we recommend using the application circuit show in Design Reference of this datasheet.

Selection Guide

Part No.	Output Power	Nominal Output Voltage and Current (Vo/Io)	Efficiency at 230VAC (%) Typ.	Capacitive Load (μF)Max.
LO03-10B03	2.3W	3.3V/700mA	69	3000
LO03-10B05	3W	5V/600mA	73	3000
LO03-10B09		9V/330mA	76	1000
LO03-10B12		12V/250mA	78	1000
LO03-10B15		15V/200mA	78	500
LO03-10B24		24V/125mA	79	330

Input Specifications

Item	Operating Conditions	Min.	Typ.	Max.	Unit
Input Voltage Range	AC input	85	--	264	VAC
	DC input	100	--	370	VDC
Input Frequency		47	--	60	Hz
Input Current	115VAC	--	--	0.09	A
	230VAC	--	--	0.055	
Inrush Current	115VAC	--	10	--	
	230VAC	--	20	--	
Leakage Current	264VAC	0.25mA RMS Max.			
Recommended External Input Fuse		1A/250V slow-blow required			
Hot Plug		Unavailable			

Output Specifications

Item	Operating Conditions	Min.	Typ.	Max.	Unit
Output Voltage Accuracy	3.3V output	--	±6	--	%
	others	--	±5	--	
Line Regulation	3.3V output	--	±2.5	--	
	others	--	±1.5	--	
Load Regulation	10% -100% load	--	±3	--	
Ripple & Noise*	20MHz bandwidth (peak-to-peak value)	--	80	150	mV
Temperature Coefficient		--	±0.02	--	%/°C
Stand-by Power Consumption		--	--	0.5	W
Short Circuit Protection		Hiccup, continuous, self-recovery			
Overcurrent Protection		130 - 400%Io self-recovery			
Min. Load		10	--	--	%

Starting Time	230VAC input	--	2000	--	ms
Hold-up Time	115VAC input	--	5	--	
	230VAC input	--	20	--	

Note: * The "Tip and barrel method" is used for Ripple and noise test, please refer to AC-DC Converter Application Notes for specific information.

General Specifications

Item	Operating Conditions	Min.	Typ.	Max.	Unit
Isolation	Input-output	Electric Strength Test for 1min. (leakage current < 5mA)			VAC
Operating Temperature		-25	--	+70	°C
Storage Temperature		-25	--	+85	
Storage Humidity		--	--	90	%RH
Altitude		--	--	2000	m
Soldering Temperature	Wave-soldering	260 ± 5°C; time: 5 - 10s			
	Manual-welding	360 ± 10°C; time: 3 - 5s			
Power Derating	-25°C to -10°C	1	--	--	% / °C
	+50°C to +70°C	3	--	--	
	85VAC-100VAC	1.67	--	--	%VAC
Safety Standard		IEC62368/UL62368/EN62368			
Safety Class		CLASS II			
MTBF		MIL-HDBK-217F@25°C > 300,000 h			

Mechanical Specifications

Dimension	42.00 x 16.00 x 17.00 mm
Weight	9g (Typ.)
Cooling Method	Free air convection

Electromagnetic Compatibility (EMC)

Emissions	CE	CISPR32/EN55032	CLASS A	
		CISPR32/EN55032	CLASS B (See Fig. 2 for recommended circuit)	
	RE	CISPR32/EN55032	CLASS A	
		CISPR32/EN55032	CLASS B (See Fig. 2 for recommended circuit)	
Immunity	ESD	IEC/EN61000-4-2	±6KV (See Fig. 2 for recommended circuit)	Perf. Criteria B
	RS	IEC/EN61000-4-3	10V/m (See Fig. 2 for recommended circuit)	perf. Criteria A
	EFT	IEC/EN61000-4-4	±2KV (See Fig. 2 for recommended circuit)	perf. Criteria B
	Surge	IEC/EN61000-4-5	±1KV (See Fig. 2 for recommended circuit)	perf. Criteria B
	CS	IEC/EN61000-4-6	10 Vr.m.s (See Fig. 2 for recommended circuit)	perf. Criteria A
	Voltage dips, short interruptions and voltage variations immunity	IEC/EN61000-4-11	0%,70%	perf. Criteria B

Product Characteristic Curve

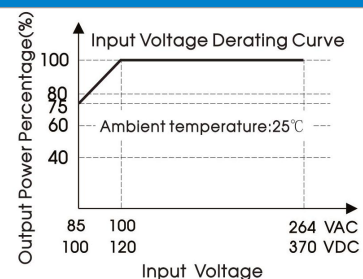
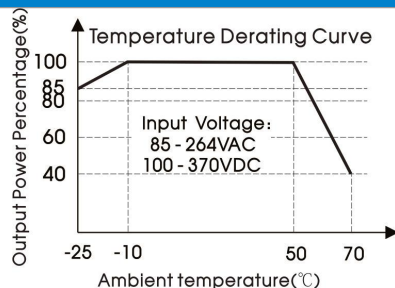

Note: ① With an AC input voltage between 85-100VAC and a DC input between 100-120VDC the output power must be derated as per temperature derating curves;

② This product is suitable for applications using natural air cooling; for applications in closed environment please consult factory or one of our FAE.

Efficiency Vs Input Voltage (Full Load)

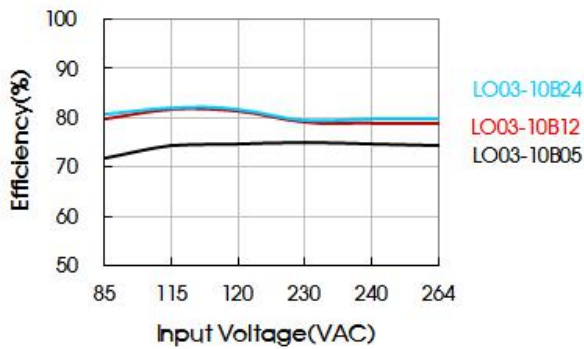

Efficiency Vs Output Load (Vin=230VAC)

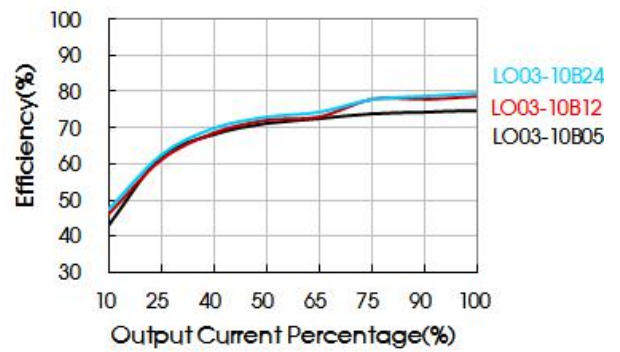

Design Reference

1. Typical application circuit

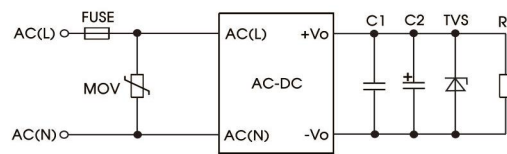

Fig. 1: Typical circuit diagram

Model	C1(μF)	C2(μF)	FUSE	MOV	TVS tube
LO03-10B03	1	150	1A/250V slow-blow required	S14K300	SMBJ7.0A
LO03-10B05		150			SMBJ7.0A
LO03-10B09		120			SMBJ12A
LO03-10B12		120			SMBJ20A
LO03-10B15		120			SMBJ20A
LO03-10B24		68			SMBJ30A

Note:
We recommend using electrolytic capacitors with high frequency and low ESR rating for C2 (refer to manufacture's datasheet). Choose a Capacitor voltage rating with at least 20% margin, in other words not exceeding 80%. C1 is ceramic capacitors used for filtering high-frequency noise and TVS is a recommended suppressor diode to protect the application in case of a converter failure.

2. EMC solution-recommended circuit

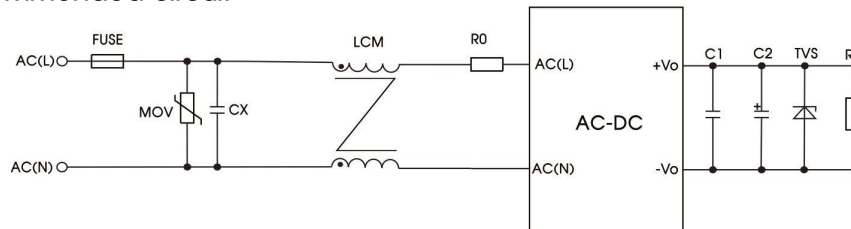
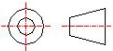

Fig 2: EMC application circuit with higher requirements

Element model	Recommended value
MOV	S14K300
CX	0.1μF/275VAC
LCM	10mH - 30mH, recommended to use MORNSUN's FL2D-Z5-103
FUSE	2A/250V slow-blow required
R0	33 Ω /3W

3. For additional information about Mornsun and their EMC Filter products, please refer to www.mornsun-power.com

Dimensions and Recommended Layout

THIRD ANGLE PROJECTION 

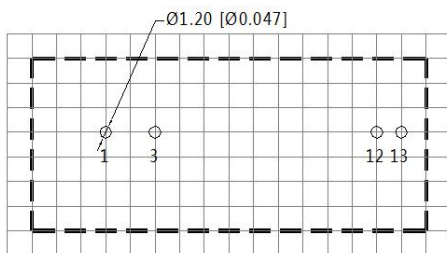
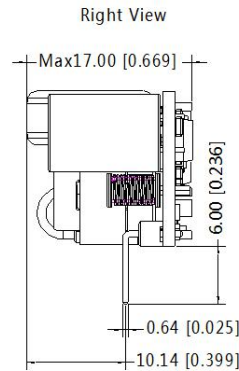
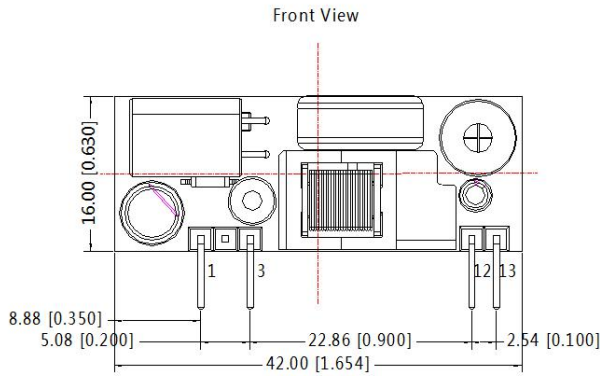

Note: Grid 2.54*2.54mm

Note:
Unit: mm[inch]
Connect pin size: $\square 0.64[0.025]$
Pin section tolerances: $\pm 0.10[\pm 0.004]$
General tolerances: $\pm 0.50[\pm 0.020]$

Pin-Out			
Pin	Function	Pin	Function
1	AC(N)	12	+Vo
3	AC(L)	13	-Vo

Notes:

- For additional information on Product Packaging please refer to www.mornsun-power.com. Packaging bag number: 58220058 ;
- If the product is not operated within the required load range, the product performance cannot be guaranteed to comply with all parameters in the datasheet;
- Unless otherwise specified, parameters in this datasheet were measured under the conditions of $T_a=25\text{ }^\circ\text{C}$, humidity<75% with nominal input voltage and rated output load;
- All index testing methods in this datasheet are based on our Company's corporate standards;
- The performance parameters of the product models listed in this manual are as above, but some parameters of non-standard model products may exceed the requirements mentioned above. Please contact our technicians directly for specific information;
- We can provide product customization service;
- Products are related to laws and regulations: see "Features" and "EMC";
- Our products shall be classified according to ISO14001 and related environmental laws and regulations, and shall be handled by qualified units.

MORNSUN Guangzhou Science & Technology Co., Ltd.

Address: No. 5, Kehui St. 1, Kehui Development Center, Science Ave., Guangzhou Science City, Luogang District, Guangzhou, P. R. China
Tel: 86-20-38601850 Fax: 86-20-38601272 E-mail: sales@mornsun.cn www.mornsun-power.com