

# MORNSUN®

## H\_S-1W & G\_S-1W Series 1W, FIXED INPUT, ISOLATED & UNREGULATED SINGLE / DUAL OUTPUT

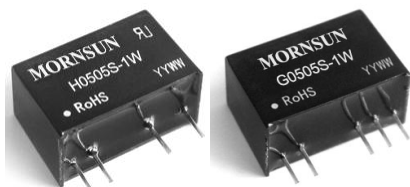

Patent Protected RoHS



Continuous Short  
Circuit Protection

### FEATURES

- SIP package
- 6000VDC isolation
- Operating temperature range: -40°C ~ +105°C
- Efficiency up to 80%
- Internal SMD construction
- No external component required
- Industry standard pinout

### PART NUMBER SYSTEM

G0505S-1W

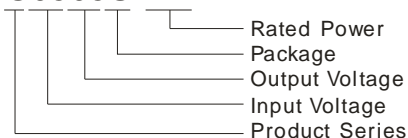

### APPLICATIONS

The H\_S-1W & G\_S-1W Series are designed for application where isolated output is required from a distributed power system.

These products apply to where:

- 1) Input voltage range:  $\pm 10\%V_{in}$ ;
- 2) 6000VDC input and output isolation;

Such as: digital circuit, low frequency analog circuit, and relay drive circuit.

### SELECTION GUIDE

Model	Input Voltage(VDC)	Output Voltage (VDC)	Output Current (mA)		Input Current (mA, Typ.)		Reflected Ripple Current (mA, Typ.)	Max. Capacitive Load(μF)	Efficiency (% Typ.)	Approval				
	Nominal (Range)		Max.	Min.	@Max. Load	@No Load								
H0503S-1W	5 (4.5-5.5)	3.3	303	30	278	30	15	220	72					
H0505S-1W		5	200	20	256				78	UL				
H0509S-1W		9	111	12	253				79	UL				
H0512S-1W		12	84	9	253				79	UL				
H0515S-1W		15	67	7	253				79	UL				
H0524S-1W		24	42	4	250				80					
G0505S-1W		±5	±100	±10	256				78					
G0507S-1W		±7.2	±70	±7	256				78					
G0509S-1W		±9	±56	±6	253				79					
G0512S-1W		±12	±42	±5	253				79					
G0515S-1W		±15	±33	±4	253				79					
H1205S-1W		12 (10.8-13.2)	5	200	20				104	20	5	220	80	UL
H1207S-1W	7.2		139	14	104	80								
H1209S-1W	9		111	12	102	82	UL							
H1212S-1W	12		84	9	103	81	UL							
H1215S-1W	15		67	7	102	82	UL							
G1205S-1W	±5		±100	±10	104	80								
G1207S-1W	±7.2		±70	±7	104	80								
G1209S-1W	±9		±56	±6	102	82								
G1212S-1W	±12		±42	±5	103	81								
G1215S-1W	±15		±33	±4	102	82								
H1505S-1W	15 (13.5-16.5)		5	200	20	82	15	5	220				80	
H1509S-1W			9	111	11	82							80	
G1505S-1W		±5	±100	±10	82	80								
G1515S-1W		±15	±33	±4	81	81								
H2403S-1W	24 (21.6- 26.4)	3.3	303	30	58	10	5	220	72					
H2405S-1W		5	200	20	52				80					
H2412S-1W		12	84	9	52				80					
H2415S-1W		15	67	7	52				80					
G2412S-1W		±12	±42	±5	52				80					

## INPUT SPECIFICATIONS

Item	Test Conditions	Min.	Typ.	Max.	Unit
Input Surge Voltage (1 sec. max.)	5VDC Input	-0.7	--	9	
	12VDC Input	-0.7	--	18	
	15VDC Input	-0.7	--	21	
	24VDC Input	-0.7	--	30	
Input Filter		Capacitor			

## OUTPUT SPECIFICATIONS

Item	Test Conditions	Min.	Typ.	Max.	Unit	
Output Voltage Accuracy		See tolerance envelope curve				
Line Regulation	For Vin change of $\pm 1\%$	--	--	$\pm 1.2$	%	
Load Regulation	10% to 100% load	3.3VDC output	--	15		--
		5VDC output	--	12		--
		7.2&9VDC output	--	8		--
		12VDC output	--	7		--
		15VDC output	--	6		--
		24VDC output	--	5		--
Temperature coefficient	100% load	--	--	$\pm 0.03$	%/°C	
Ripple & Noise*	20MHz Bandwidth	Output Voltage $\leq 12$ VDC	--	100	--	mVp-p
		Output Voltage :15VDC, 24VDC	--	150	--	
Short Circuit Protection		Continuous, automatic recovery				

Note:\* Ripple and noise tested with "parallel cable" method. See detailed operation instructions at *DC-DC Application Notes*.

## COMMON SPECIFICATIONS

Item	Test Conditions	Min.	Typ.	Max.	Unit
Isolation Voltage	Input-Output, tested for 1 minute and leakage current less than 1 mA	6000	--	--	VDC
Isolation Resistance	Input-Output, test at 500VDC	1000	--	--	MΩ
Isolation Capacitance	Input-Output, 100KHz/0.1V	--	10	--	pF
Switching Frequency	Full load, nominal input	--	50	--	KHz
MTBF	MIL-HDBK-217F @ 25°C	3500	--	--	K hours
Case Material		Plastic (UL94-V0)			
Weight		--	4.2	--	g

## ENVIRONMENTAL SPECIFICATIONS

Item	Test Conditions	Min.	Typ.	Max.	Unit
Storage Humidity	Non condensing	--	--	95	%
Operating Temperature	Power derating ( $\geq 100^\circ\text{C}$ , see Figure 2)	-40	--	105	°C
Storage Temperature		-55	--	125	
Temperature rise	Ta=25°C, 100% Load	--	25	--	
Lead Temperature	1.5mm from case for 10 seconds	--	--	300	
Cooling		Free air convection			

## EMC SPECIFICATIONS

EMI	CE	CISPR22/EN55022 CLASS B (Typical Recommended Circuit Refer to Figure1)			
	RE	CISPR22/EN55022 CLASS B (Typical Recommended Circuit Refer to Figure1)			
EMS	ESD	IEC/EN61000-4-2 Contact $\pm 8$ KV perf. Criteria B			

# EMC RECOMMENDED CIRCUIT

EMI Typical Recommended Circuit (CLASS B):

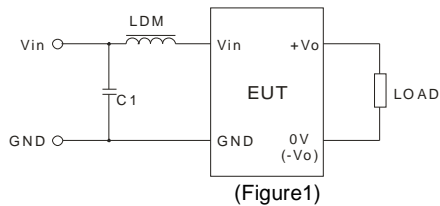

Recommended typical circuit parameters:

	Vin(V)	5/12/15/24
EMI	C1	4.7μF /50V
	LDM	6.8μH

# EMC TEST WAVEFORM (RECOMMENDED CIRCUIT FIGURE 1)

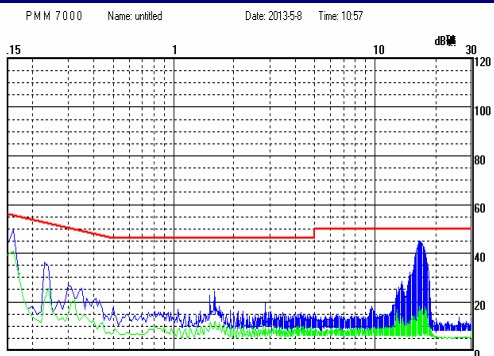

H0505S-1W CE(Positive line)

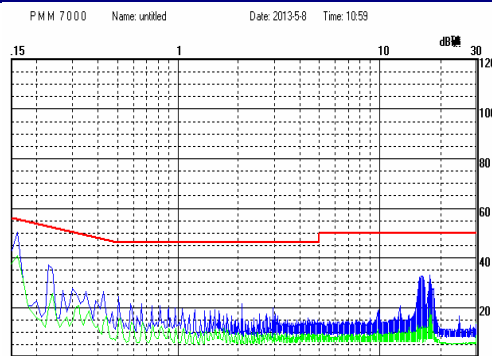

H0505S-1W CE(Negative, line)

# PRODUCT TYPICAL CURVE

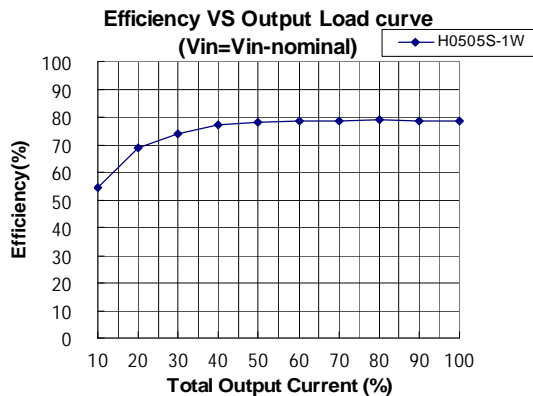
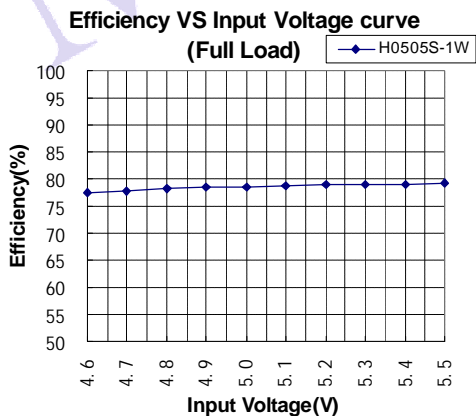
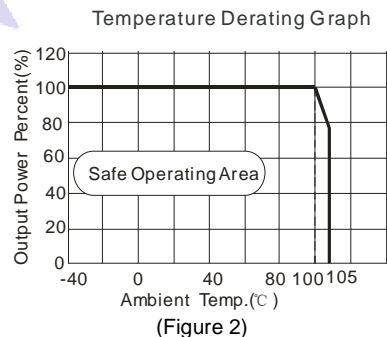
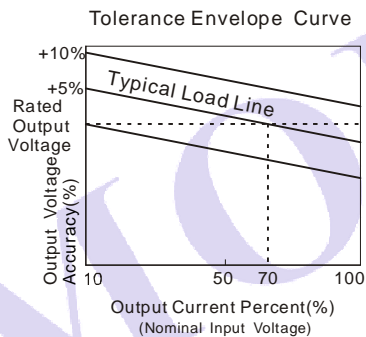

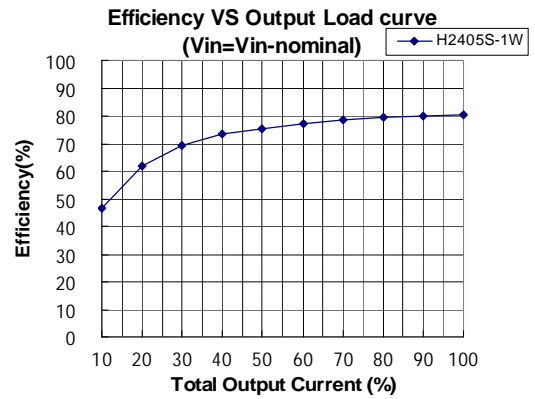
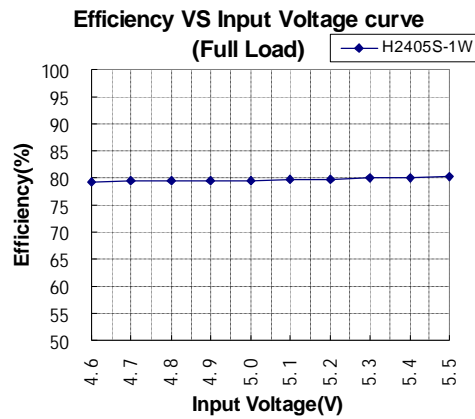

## DIMENSIONS, RECOMMENDED FOOTPRINT & PACKAGING

### MECHANICAL DIMENSIONS

Front view dimensions: 0.50 [0.020] (height), 12.50 [0.492] (width), 0.50 [0.020] (pin offset), 4.10 [0.161] (pin length).

Bottom view dimensions: 19.50 [0.768] (width), 9.80 [0.386] (height), 3.20 [0.126] (pin offset), 2.54 [0.100] (pin length), 15.24 [0.600] (pin length), 0.30 [0.012] (pin length).

Pin	Single	Dual
1	Vin	Vin
2	GND	GND
5	0V	-Vo
6	No Pin	0V
7	+Vo	+Vo

Note:  
 Unit :mm[inch]  
 Pin section tolerances:±0.1mm[±0.004inch]  
 General tolerances:±0.25mm[±0.01inch]

THIRD ANGLE PROJECTION

### RECOMMENDED FOOTPRINT DETAILS

Dual footprint: 7 pins, 1.00 [0.039] pitch.

Single footprint: 7 pins, 1.00 [0.039] pitch.

Note:Grid 2.54\*2.54mm

### TUBE PACKAGING DIMENSIONS

Tube dimensions: 14.00 [0.551] (width), 12.00 [0.472] (height), 20.00 [0.787] (length), 5.70 [0.224] (height).

Note:  
 Unit :mm[inch]  
 General tolerances :±0.5mm[±0.020inch]  
 L=530mm[20.866 inch] Tube Quantity:25 pcs  
 L=220mm[8.661 inch] Tube Quantity:10 pcs  
 Inner carton(S): L\*W\*H=255\*170\*80 mm;  
 Outer carton(S): L\*W\*H=375\*280\*270mm, 6 inner cartons(S);  
 Inner carton(L): L\*W\*H=580\*200\*100mm;  
 Outer carton(L): L\*W\*H=600\*215\*220mm, 2 inner cartons(L);  
 Outer carton(L): L\*W\*H=600\*215\*325mm, 3 inner cartons(L);

## TEST CONFIGURATIONS

### Input Reflected-Ripple Current Test Setup

Input reflected-ripple current is measured with an inductor Lin and Capacitor Cin to simulate the source impedance .

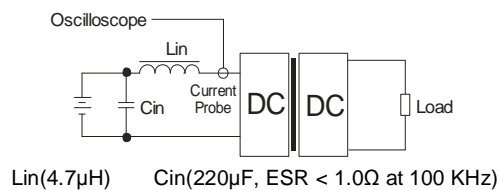

## DESIGN CONSIDERATIONS

### 1) Requirement for output load

To ensure this module can operate efficiently and reliably, the minimum output load could not be less than 10% of the full load. If the actual output power is very small, please connect a resistor to the output in parallel to increase the load.

### 2) Overload Protection

Under normal operating conditions, the output circuit of these products have not overload protection. The simplest method is to add a breaker circuit in the circuit.

### 3) Recommended circuit

If you want to further decrease the input/output ripple, an capacitor filtering network may be connected to the input and output ends of the DC/DC converter, refer to Figure 3.

It should also be noted that the capacitance of the capacitor must be proper. If the capacitance is too large, a startup problem might arise. For ensuring every channel of output can provide a safe and reliable operation, the recommended capacitance of the capacitor refer to Table 1.

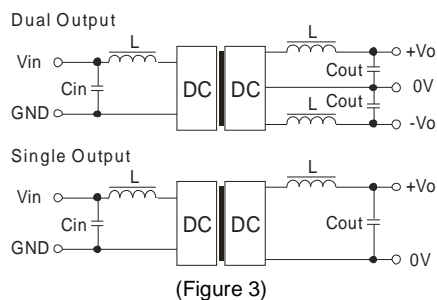

EXTERNAL CAPACITOR TABLE (Table 1)

Vin (VDC)	Cin (μF)	Single Vout (VDC)	Cout (μF)	Dual Vout (VDC)	Cout (μF)
5	4.7	3.3	10	--	--
5	4.7	5	10	±5	4.7
12	2.2	9	4.7	±9	2.2
15	2.2	12	2.2	±12	2.2
24	1	15	1	±15	1

It's not recommended to connect any external capacitor in the application field with less than 0.5 watt output.

4) The input and the output of the product are recommended to be connected to ceramic capacitor or electrolytic capacitor. Using tantalum capacitor may cause risk of failure.

5) It is not recommended to increase the output power capability by connecting two or more converters in parallel. The product is not hot-swappable

Note:

1. Operation under minimum load will not damage the converter; However, they may not meet all specifications.
2. Max. Capacitive Load is tested at nominal input voltage and full load.
3. Unless otherwise noted, All specifications are measured at Ta=25°C, humidity<75%, nominal input voltage and rated output load.
4. In this datasheet, all test methods are based on our corporate standards.
5. All characteristics are for listed models, and non-standard models may perform differently. Please contact our technical support for more detail.
6. Please contact our technical support for any specific requirement.
7. Specifications of this product are subject to changes without prior notice.

### **MORNSUN Science & Technology Co.,Ltd.**

Address: No. 5, Kehui St. 1, Kehui development center, Science Ave., Guangzhou Science City, Luogang district, Guangzhou, P.R.China.

Tel: 86-20-38601850

Fax: 86-20-38601272

E-mail: [info@mornsun.cn](mailto:info@mornsun.cn)

[Http://www.mornsun-power.com](http://www.mornsun-power.com)