

1W isolated DC-DC converter  
Fixed input voltage and unregulated dual/single output

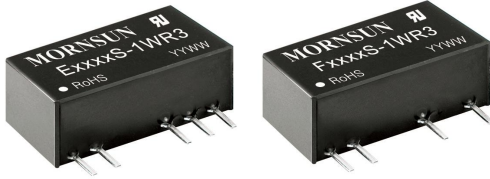

UL US CE CB Patent Protection RoHS

FEATURES

- Continuous short-circuit protection
- No-load input current as low as 5mA
- Operating ambient temperature range: -40°C ~ +105°C
- High efficiency up to 85%
- I/O isolation test voltage: 3K VDC
- Industry standard pin-out
- SIP package
- IEC62368, UL62368, EN62368 approved

E05\_S-1WR3 & F05\_S-1WR3 series are specially designed for applications where an isolated (two isolated) voltage is required in a distributed power supply system. They are suitable for: pure digital circuits, low frequency analog circuits, relay-driven circuits and data switching circuits.

Selection Guide

Certification	Part No.	Input Voltage(VDC)	Output		Full Load Efficiency(%) Min./Typ.	Capacitive Load(µF) Max.
		Nominal ( Range )	Voltage (VDC)	Current(mA) Max./Min.		
CE	E0503S-1WR3	5 (4.5-5.5)	±3.3	±152/±15	70/74	1200
	E0505S-1WR3		±5	±100/±10	78/82	1200
UL/CE/CB	E0509S-1WR3		±9	±56/±6	79/83	470
	E0512S-1WR3		±12	±42/±5	79/83	220
	E0515S-1WR3		±15	±34/±4	79/83	
	E0524S-1WR3		±24	±21/±3	81/85	100
	F0503S-1WR3		3.3	303/30	70/74	2400
	F0505S-1WR3		5	200/20	78/82	
	F0509S-1WR3		9	111/12	79/83	1000
	F0512S-1WR3		12	84/9	79/83	560
	F0515S-1WR3		15	67/7	79/83	
	F0524S-1WR3		24	42/4	81/85	220

Note: \*The specified maximum capacitive load for positive and negative output is identical.

Input Specifications

Item	Operating Conditions	Min.	Typ.	Max.	Unit
Input Current (full load / no-load)	3.3VDC/5VDC output	--	270/5	286/10	mA
	9VDC/12VDC output	--	241/12	254/20	
	15VDC/24VDC output	--	241/18	254/30	
Reflected Ripple Current*		--	15	--	
Surge Voltage (1sec. max.)	5 VDC input	-0.7	--	9	VDC
Input Filter		Capacitance filter			
Hot Plug		Unavailable			

Note: \* Refer to DC-DC Converter Application Notes for detailed description of reflected ripple current test method.

Output Specifications

Item	Operating Conditions	Min.	Typ.	Max.	Unit	
Voltage Accuracy		See output regulation curve(Fig. 1)				
Linear Regulation	Input voltage change: ±1%	3.3 VDC output	--	--	1.5	%/%
		Other output	--	--	1.2	
Load Regulation	10%-100% load	3.3VDC output	--	15	20	%
		5VDC output	--	10	15	
		9VDC output	--	8	10	

Load Regulation	10%-100% load	12VDC output	--	7	10	%
		15VDC output	--	6	10	
		24VDC output	--	5	10	
Ripple & Noise*	20MHz bandwidth	Other output	--	30	75	mVp-p
		24VDC output	--	50	100	
Temperature Coefficient	100% load		--	±0.02	--	%/°C
Short-circuit Protection			Continuous, self-recovery			
Note:* The "parallel cable" method is used for Ripple and Noise test, please refer to DC-DC Converter Application Notes for specific information.						

General Specifications

Item	Operating Conditions	Min.	Typ.	Max.	Unit
Isolation	Input-output Electric Strength Test for 1 minute with a leakage current of 1mA max.	3000	--	--	VDC
Insulation Resistance	Input-output resistance at 500VDC	1000	--	--	MΩ
Isolation Capacitance	Input-output capacitance at 100kHz/0.1V	--	20	--	pF
Operating Temperature	Derating if the temperature ≥85°C (see Fig. 2)	-40	--	105	°C
Storage Temperature		-55	--	125	
Case Temperature Rise	Ta=25°C	3.3VDC output	--	25	
		Others	--	15	--
Pin Soldering Resistance Temperature	Soldering spot is 1.5mm away from case for 10 seconds	--	--	300	
Storage Humidity	Non-condensing	--	--	95	%RH
Switching Frequency	100% load, nominal input voltage	--	270	--	KHz
MTBF	MIL-HDBK-217F@25°C	3500	--	--	K hours

Mechanical Specifications

Case Material	Black plastic; flame-retardant and heat-resistant (UL94 V-0)
Dimensions	19.65 x 6.00 x 10.16mm
Weight	2.1g(Typ.)
Cooling methods	Free air convection

Electromagnetic Compatibility (EMC)

Emissions	CE	CISPR32/EN55032	CLASS B (see Fig. 4 for recommended circuit)
	RE	CISPR32/EN55032	CLASS B (see Fig. 4 for recommended circuit)
Immunity	ESD	IEC/EN61000-4-2	Air ±8kV , Contact ±4kV perf. Criteria B

Typical Characteristic Curves

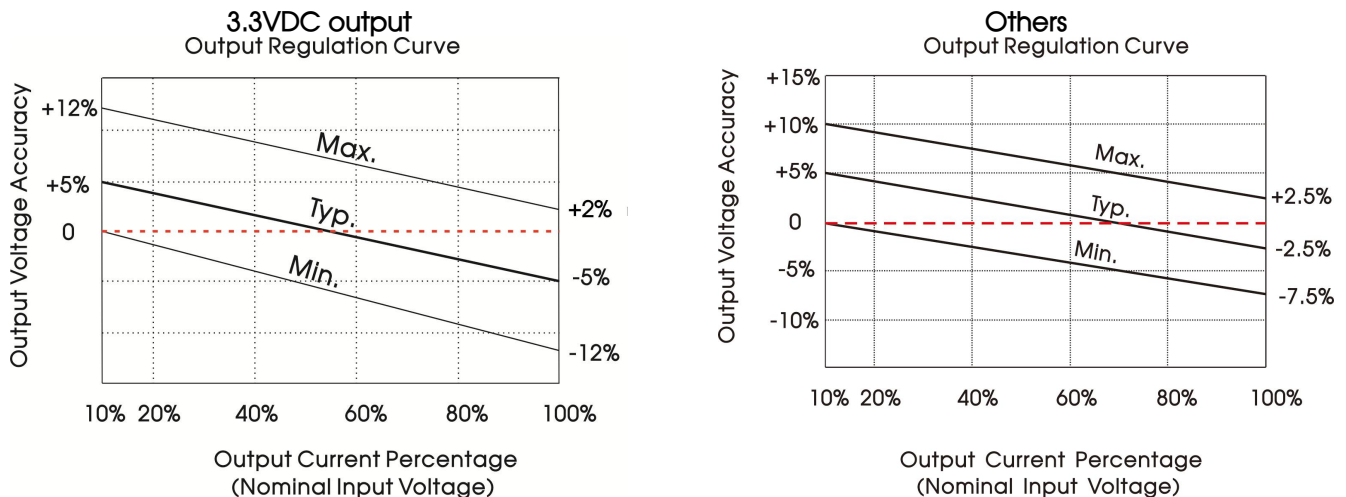

Fig. 1

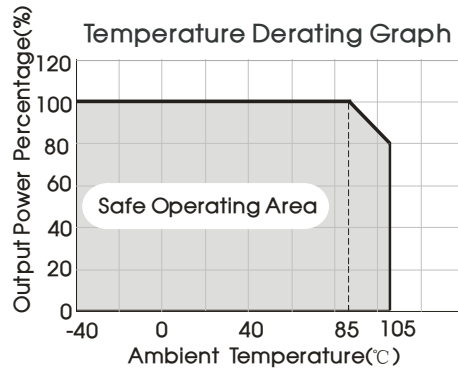
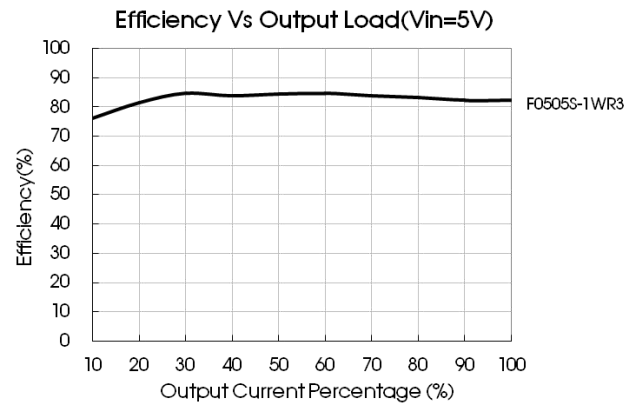
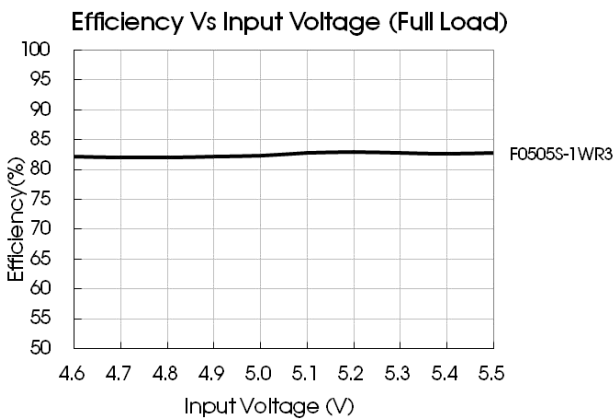
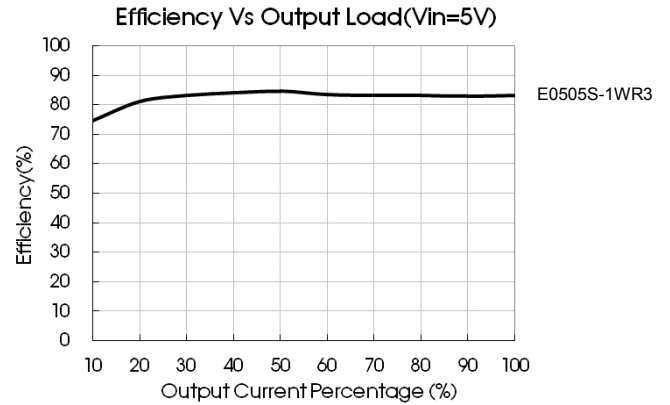
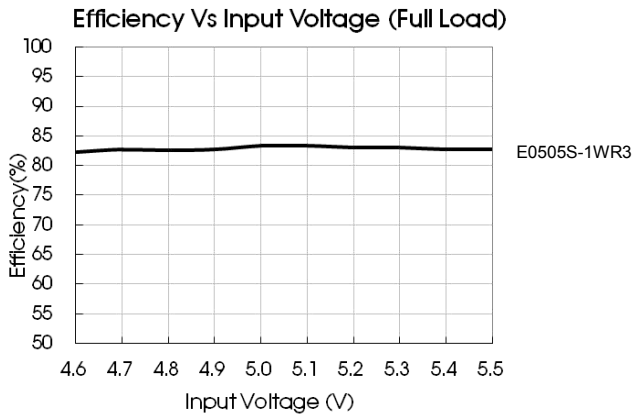

Fig. 2



## Design Reference

### 1. Typical application circuit

Input and/or output ripple can be further reduced, by connecting a filter capacitor from the input and/or output terminals to ground as shown in Fig. 3.

Choosing suitable filter capacitor values is very important for a smooth operation of the modules, particularly to avoid start-up problems caused by capacitor values that are too high. For recommended input and output capacitor values refer to Table 1.

Dual Output



Single Output



Fig.3

Recommended capacitive load value table (Table 1)

Vin (VDC)	Cin (μF)	Single output (VDC)	Cout (μF)	Dual output (VDC)	Cout (μF)
5	4.7	3.3/5	10	±3.3/±5	4.7
--	--	9/12	2.2	±9/±12	1
--	--	15/24	1	±15/±24	0.47

2. EMC (CLASS B) compliance circuit

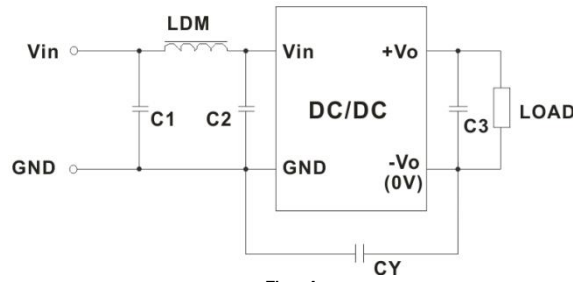

Fig. 4

EMC recommended circuit value table (Table 2)

Input voltage 5VDC	Output voltage (VDC)		3.3/5/9	12/15/24
	EMI	C1/C2	4.7μF /25V	4.7μF /25V
CY		--	--	1nF/4KVDC VISHAY HGZ102MBP TDK CD45-E2GA102M-GKA
C3		Refer to the Cout in table 1		
LDM		6.8μH	6.8μH	6.8μH

Note: In the case of actual use, the requirements for EMI are high, it is subject to CY (CY:1nF/4KV).

3. For additional information please refer to DC-DC converter application notes on [www.mornsun-power.com](http://www.mornsun-power.com).

Dimensions and Recommended Layout

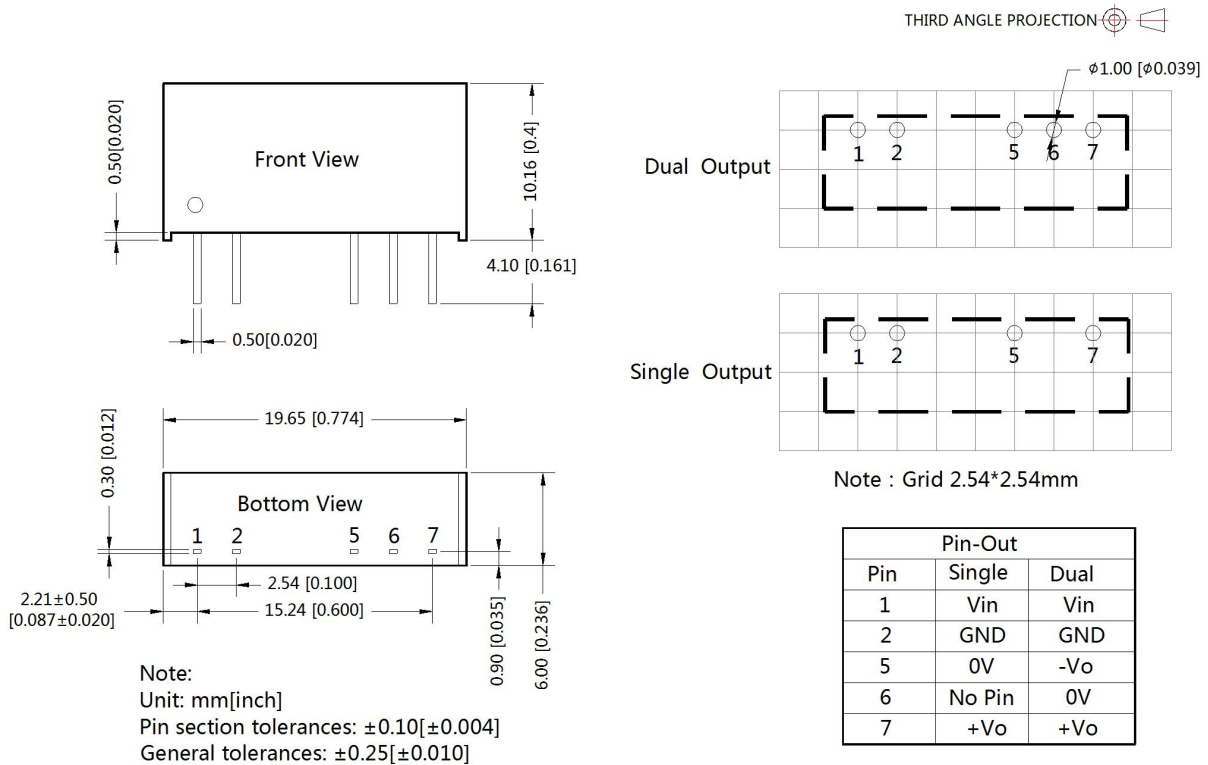

Notes:

1. For additional information on Product Packaging please refer to [www.mornsun-power.com](http://www.mornsun-power.com). Packaging bag number: 58200001;
2. If the product is not operated within the required load range, the product performance cannot be guaranteed to comply with all parameters in the datasheet;
3. The maximum capacitive load offered were tested at input voltage range and full load;
4. Unless otherwise specified, parameters in this datasheet were measured under the conditions of  $T_a=25^{\circ}\text{C}$ , humidity<75%RH with nominal input voltage and rated output load;
5. All index testing methods in this datasheet are based on our company corporate standards;
6. We can provide product customization service, please contact our technicians directly for specific information;
7. Products are related to laws and regulations: see "Features" and "EMC";
8. Our products shall be classified according to ISO14001 and related environmental laws and regulations, and shall be handled by qualified units.

MORNSUN Guangzhou Science & Technology Co., Ltd.

Address: No. 5, Kehui St. 1, Kehui Development Center, Science Ave., Guangzhou Science City, Huangpu District, Guangzhou, P. R. China  
Tel: 86-20-38601850 Fax: 86-20-38601272 E-mail: [info@mornsun.cn](mailto:info@mornsun.cn) [www.mornsun-power.com](http://www.mornsun-power.com)