

1W isolated DC-DC converter
Fixed input voltage and unregulated single output



Patent Protection **RoHS**

FEATURES

- Operating ambient temperature range: -40°C ~ +105°C
- I/O isolation test voltage 1k VDC
- Compact SMD package
- Internal surface mounted design
- Industry standard pin-out
- The production process meets TS16949 system requirement

The CB0505XT-1W is designed for application where isolated output is required from a distributed power system. It can be used in automobile motor control and drive system, such as motor vehicle communication system controller, engine control system, the ignition system, the motor voltage monitoring, the electronic accelerator pedal, automobile tire pressure detection system, doors and tail lights controller, air conditioning control and battery management system (BMS), etc.

Selection Guide

Part No.	Input Voltage (VDC)	Output		Full Load Efficiency (%) Min./Typ.	Capacitive Load (µF) Max.
	Nominal (Range)	Voltage (VDC)	Current(mA) Max./Min.		
CB0505XT-1W	5 (4.5-5.5)	5	200/20	72/76	33

Input Specifications

Item	Operating Conditions	Min.	Typ.	Max.	Unit
Input Current (full load / no-load)		--	267/24	--	mA
Surge Voltage (1sec. max.)		-0.7	--	9	VDC
Input Filter		Capacitance filter			
Hot Plug		Unavailable			

Output Specifications

Item	Operating Conditions	Min.	Typ.	Max.	Unit
Voltage Accuracy		See output regulation curve(Fig. 1)			
Linear Regulation	Input voltage change: ±1%	--	--	±1.2	--
Load Regulation	10%-100% load	--	12.8	15	%
Ripple *	20MHz bandwidth	--	40	75	mVp-p
Noise*		--	60	100	
Temperature Coefficient	100% load	--	--	±0.03	%/°C
Short-circuit Protection**		--	--	1	s

Note: * The "parallel cable" method is used for Ripple and Noise test, please refer to DC-DC Converter Application Notes for specific information;

** Supply voltage must be discontinued at the end of short-circuit duration.

General Specifications

Item	Operating Conditions	Min.	Typ.	Max.	Unit
Isolation	Input-output Electric Strength Test for 1 minute with a leakage current of 1mA max.	1000	--	--	VDC
Insulation Resistance	Input-output resistance at 500VDC	1000	--	--	MΩ
Isolation Capacitance	Input-output capacitance at 100kHz/0.1V	--	30	--	pF
Operating Temperature	Derating when operating temperature ≥ 85°C. (see Fig. 2)	-40	--	105	°C
Storage Temperature		-55	--	125	
Case Temperature Rise	Ta=25°C	--	25	--	

Reflow Soldering Temperature		Peak temp. ≤225°C, maximum duration time ≤60s over 200°C. For actual application, please refer to IPC/JEDEC J-STD-020D.1.			
Storage Humidity	Non-condensing	--	--	95	%/RH
Switching Frequency	100% load, nominal input voltage	--	125	--	KHz
MTBF	MIL-HDBK-217F@25°C	3500	--	--	K hours

Mechanical Specifications

Case Material	Black Epoxy resin; flame-retardant and heat-resistant (UL94 V-0)
Dimensions	12.70 x 11.20 x 6.25mm
Weight	1.4g(Typ.)
Cooling Methods	Free air convection

Electromagnetic Compatibility (EMC)

Emissions	CE	CISPR25/EN55025 CLASS 1 (see Fig. 5 for recommended circuit)
Immunity	ESD	ISO10605 Contact ±6KV perf. Criteria B

Typical Characteristic Curves

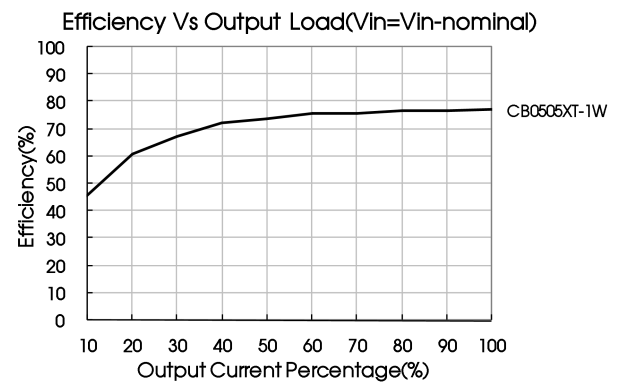
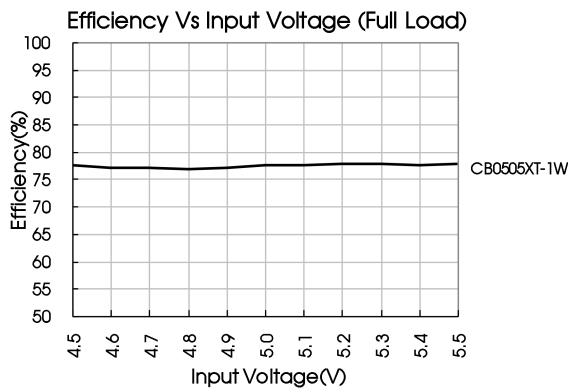
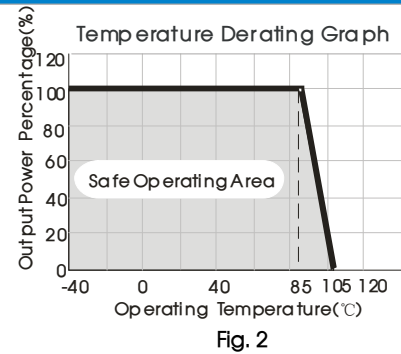
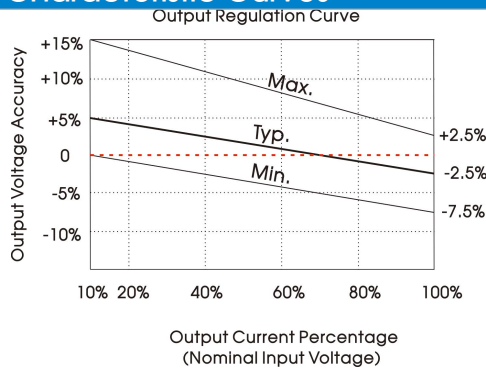

Design Reference

1. Typical application

Input and/or output ripple can be further reduced, by connecting a filter capacitor from the input and/or output terminals to ground as shown in Fig. 3.

Choosing suitable filter capacitor values is very important for a smooth operation of the modules, particularly to avoid start-up problems caused by capacitor values that are too high. For recommended input and output capacitor values refer to Table 1.

The simplest device for output voltage regulation, over-voltage and over-current protection is a linear regulator with overheat protection which is connected to the input or output in series (Fig. 4)

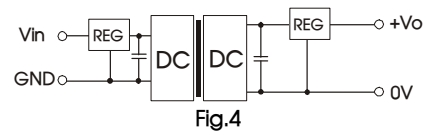
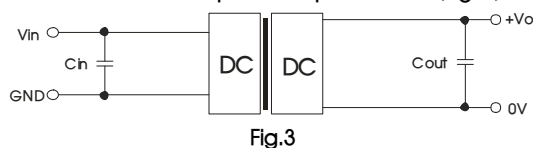

Recommended capacitive load value table (Table 1)

Vin(VDC)	Cin(μF)	Vo (VDC)	Cout(μF)
5	4.7	5	10

It is not recommended to connect any external capacitor when output power is less than 0.5W.

2. EMC (CLASS 1) compliance circuit

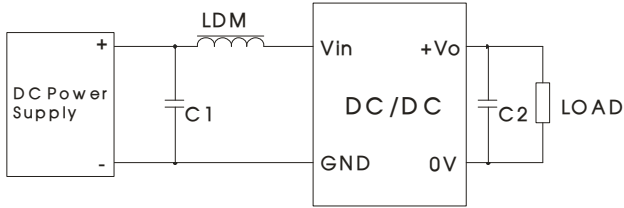

Input voltage (V)		5
Emissions	C1	4.7μF /50V
	LDM	6.8μH
	C2	Refer to the Cout in Fig.3

Fig. 5

3. Output load requirements

To ensure the module work efficiently and reliably, during the operation, the min. output load should be no less than 10% of the full load. If the actual output power is low, please connect a resistor to the output terminal in parallel, with a recommended resistance which is 10% of the rated power, and derating is required during operation.

4. For additional information please refer to DC-DC converter application notes on

www.mornsun-power.com.

Dimensions and Recommended Layout

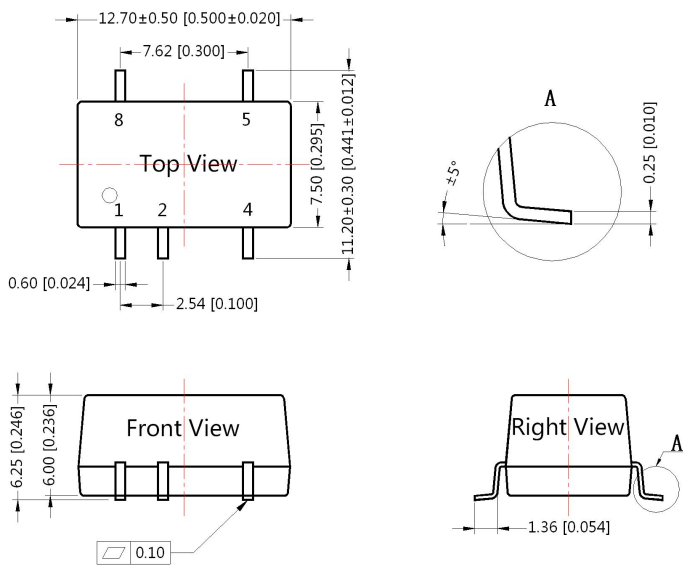

Note:
Unit: mm[inch]
Pin section tolerances: ±0.10[±0.004]
General tolerances: ±0.25[±0.010]

THIRD ANGLE PROJECTION

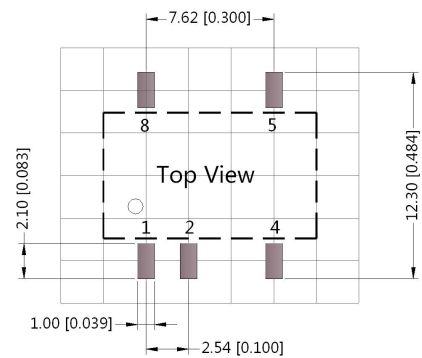

Note: Grid 2.54*2.54mm

Pin-Out	
Pin	Function
1	GND
2	Vin
4	0V
5	+Vo
8	NC

NC: No Connection

Notes:

1. For additional information on Product Packaging please refer to www.mornsun-power.com. Tube Packaging bag number: 58200021, Roll Packaging bag number: 58200031;
2. If the product is not operated within the required load range, the product performance cannot be guaranteed to comply with all parameters in the datasheet;
3. The maximum capacitive load offered were tested at nominal input voltage and full load;
4. Unless otherwise specified, parameters in this datasheet were measured under the conditions of $T_a=25^{\circ}\text{C}$, humidity<75%RH with nominal input voltage and rated output load;
5. All index testing methods in this datasheet are based on our company corporate standards;
6. We can provide product customization service, please contact our technicians directly for specific information;
7. Products are related to laws and regulations: see "Features" and "EMC";
8. Our products shall be classified according to ISO14001 and related environmental laws and regulations, and shall be handled by qualified units.

MORNSUN Guangzhou Science & Technology Co., Ltd.

Address: No. 5, Kehui St. 1, Kehui Development Center, Science Ave., Guangzhou Science City, Huangpu District, Guangzhou, P. R. China
Tel: 86-20-38601850 Fax: 86-20-38601272 E-mail: info@mornsun.cn www.mornsun-power.com